

Orientation

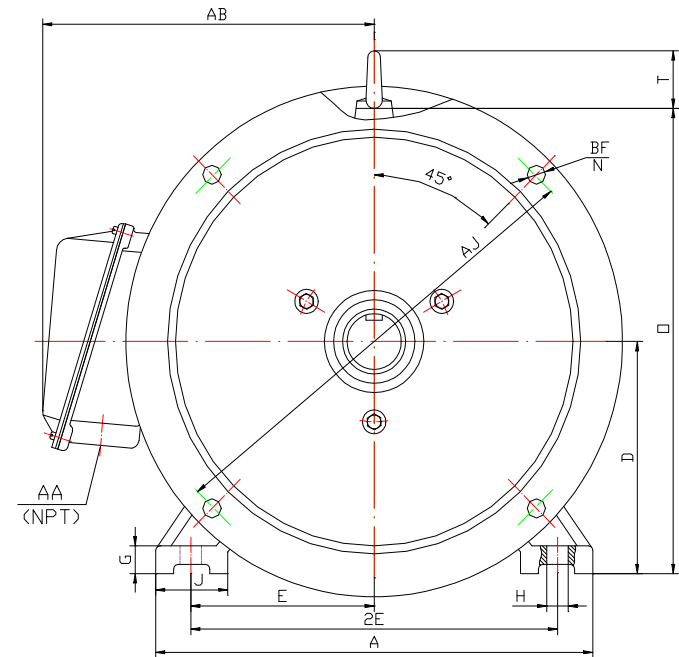
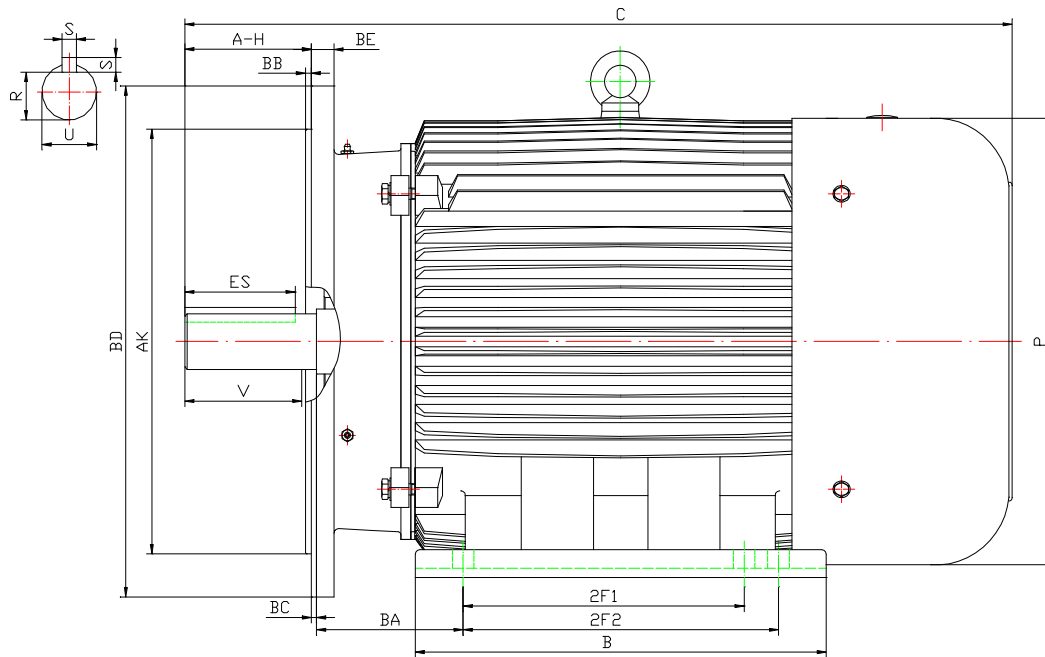
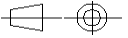

HP	RPM	Frame	WGT lb	MQP / MPP-32D
----	-----	-------	--------	---------------

A	B	C	D	G	H	J	E	2E	2F1			
11.00"	9.40"	20.40"	5.25"	0.70"	6 * 0.41"	2.40"	4.25"	8.50"	5.50"			
2F2	O	P	T	AK	AJ	AH	BA	BB	BC	BD	BE	N*BF
7.00"	10.50"	10.20"	1.90"	9.00"	11.00"	3.38"	3.50"	0.25"	0.00"	11.00"	0.50"	4*0.53"
U	V	R	S	ES	AA	AB	DE Brg	ODE Brg				
1.375"	3.12"	1.201"	0.312"	2.41"	1" NPT	8.30"	6308	6308	Revised: August 2018			

MaxMotion